

Installation and Operating Guide

VLS AIT



Advanced Digital Information Corporation

Copyright Notice

Copyright adic 1993, 1994, 1995, 1996, 1999

The information contained in this document is subject to change without notice.

This document contains proprietary information that is protected by copyright. All rights are reserved. No part of this document may be photocopied, reproduced or translated to another language without the prior written consent of adic.

adic shall not be liable for errors contained herein or for incidental or consequential damages (including lost profits) in connection with the furnishing, performance or use of this material whether based on warranty, contract, or other legal theory.

Printed in the U.S.A.

April 1999

Document Number 62-0113-01 Rev B

Corporate Headquarters:
Advanced Digital Information Corporation
Shipping Address: 10201 Willows Road NE
Redmond, WA 98052

Mailing Address: P.O. Box 97057
Redmond, WA 98073-9757

(206) 881-8004

Fax: (206) 881-2296

Customer Assistance: (206) 883-HELP

adic Europe
21-23 Avenue Saint Fiacre,
Saint Germain-en-Laye,
78100 France

33 1 3087 5300

Fax: 33 1 3087 5301

adic and adic Europe are trademarks of Advanced Digital Information Corporation.

Copyright Notice (Europe)

© *Copyright 1995 aDIC Europe*

All rights reserved. No part of this document may be copied or reproduced in any form or by any means, without prior written permission of aDIC Europe, Z.A. du Bel-Air, 21 avenue Saint-Fiacre, 78100 - Saint-Germain en Laye, FRANCE.

aDIC Europe assumes no responsibility for any errors that may appear in this document, and retains the right to make changes to these specifications and descriptions at any time, without notice.

This publication may describe designs for which patents are pending, or have been granted. By publishing this information, aDIC Europe conveys no license under any patent or any other right.

aDIC Europe makes no representation or warranty with respect to the contents of this document and specifically disclaims any implied warranties of merchantability or fitness for any particular purpose. Further, aDIC Europe reserves the right to revise or change this publication without obligation on the part of aDIC Europe to notify any person or organization of such revision or change.

Every effort has been made to acknowledge trademarks and their owners. Trademarked names are used solely for identification or exemplary purposes, any omissions are made unintentionally.

EMI/RFI Compliance

United States – FCC

WARNING: This equipment has been tested and found to comply with the limits for a Class B digital device, pursuant to Part 15 of the FCC Rules. These limits are designed to provide reasonable protection against harmful interference in a residential installation. This equipment generates, uses, and can radiate radio frequency energy and, if not installed and used in accordance with the instructions, may cause harmful interference to radio communications. However, there is no guarantee that interference will not occur in a particular installation. If this equipment does cause harmful interference to radio or television reception (which can be determined by turning the equipment off and on) the user is encouraged to try to correct the interference by one or more of the following measures:

- Re-orient or relocate the receiving antenna.
- Increase the separation between the equipment and receiver.
- Connect the equipment into an outlet on a circuit different from that to which the receiver is connected.
- Consult the dealer or an experienced radio/TV technician for help.

You may find the following booklet prepared by the Federal Communications Commission helpful: *How to Identify and Resolve Radio-TV Interference Problems*. This booklet is available from the U.S. Government Printing Office, Washington, DC 20402, Stock No. 004-000-00354-04.

Canada – Department of Communications

This digital apparatus does not exceed the Class B limits for radio noise emissions from digital apparatus as set out in the interference-causing equipment standard entitled "Digital Apparatus", ICES-003 of the Department of Communications.

Cet appareil numérique respecte les limites de bruits radioélectriques applicables aux appareils numériques de Class B prescrites dans la norme sur le matériel brouilleur: "Appareils Numériques", NMB-003 édictée par le ministre des Communications.

Shielded Cables

Shielded data cables are required in order to meet EMI/RFI limit specifications. The **adic** data cable meets this requirement. If you need a replacement cable, be sure to use an **adic** - approved shielded cable (to assure acceptability to EMI/RFI requirements).

Two or more VLS units cabled to each other on the same SCSI channel must have a ferrite bead clamped on the interface cable between the units. The ferrite bead is required to satisfy the EMI/RFI limit specification. See Appendix A for instructions on installing the ferrite bead.

Declaration of Conformity

according to EN 45014

Manufacturer's Name: Advanced Digital Information Corporation

Manufacturer's Address: 10201 Willows Road 21-23 Av. Saint-Fiacre
Redmond, Washington 98052 F-78100 Saint-Germain-en-Laye
U.S.A. France

declares, that the product:

**Product
(Produit, Erzeugnis):** VLS Series Library

**Model Number
(Marque Commercial,
Warenbezeichnung):** VLS AIT

conforms to the following international specifications, as required by 89/336/EEC & 92/31/EEC:

EMI: EN 50081-1, EN-55022 Class A
EMC: EN 50082-1, IEC 801-2, IEC 801-3, IEC 801-4
Safety: EN 60950

Supplementary Information:

Redmond, Washington U.S.A.

2/28/97



Product Engineering Mgr.

Location

Date

Signature/Title

Safety Warnings



This symbol should alert the user to the presence of "dangerous voltage" inside the product that might cause harm or electric shock.

CAUTION

**RISK OF ELECTRIC SHOCK
DO NOT OPEN**

CAUTION : TO REDUCE THE RISK OF ELECTRIC SHOCK, DO NOT REMOVE COVER (OR BACK). NO USER-SERVICEABLE PARTS INSIDE. REFER SERVICING TO QUALIFIED SERVICE PERSONNEL.

Caution

All safety and operating instructions should be read before this product is operated, and should be retained for future reference. This unit has been engineered and manufactured to assure your personal safety. Improper use can result in potential electrical shock or fire hazards. In order not to defeat the safeguards, observe the following basic rules for its installation, use and servicing.

1. Heed Warnings - All warnings on the product and in the operating instructions should be adhered to.
2. Follow Instructions - All operating and use instructions should be followed.
3. Ventilation - The product should be situated so that its location or position does not interfere with proper ventilation.
4. Heat - The product should be situated away from heat sources such as radiators, heat registers, furnaces, or other heat producing appliances.
5. Power Sources - The product should be connected to a power source only of the type directed in the operating instructions or as marked on the product.
6. Power Cord Protection - The AC line cord should be routed so that it is not likely to be walked on or pinched by items placed upon or against it, paying particular

attention to the cord at the wall receptacle, and the point where the cord exits from the product.

7. Object and Liquid Entry - Care should be taken to insure that objects do not fall and liquids are not spilled into the product's enclosure through openings.
8. Servicing - The user should not attempt to service the product beyond that described in the operating instructions. All other servicing should be referred to qualified service personnel.

Precautions

- Do not use oil, solvents, gasoline, paint thinners or insecticides on the unit.
- Do not expose the unit to moisture, to temperatures higher than 140°F (60°C) or to extreme low temperatures.
- Keep the unit away from direct sunlight, strong magnetic fields, excessive dust, humidity and electronic/electrical equipment which generates electrical noise.
- Hold the AC power plug by the head when removing it from the AC source outlet; pulling the cord can damage the internal wires.
- Use the unit on a firm level surface free from vibration, and do not place anything on top of unit.

Blank Page

Table of Contents

Copyright Notice.....	ii
Copyright Notice (Europe).....	iii
EMI/RFI Compliance.....	iv
Safety Warnings.....	vi
Precautions.....	vii
Quickstart.....	xi
Chapter 1: Getting Started.....	1
Introduction.....	2
Requirements.....	2
Unpacking and Inspecting.....	3
Equipment Description.....	4
The VLS Unit.....	4
Magazine.....	4
Media.....	5
Cleaning Cassette.....	6
System Software.....	6
Preparing the Host Computer System.....	7
Power Off the Computer.....	7
Confirm and/or Install the SCSI Host Interface.....	7
Chapter 2: Connecting the VLS.....	9
Connecting the Interface Cables.....	10
Connecting More Than One VLS.....	11
Powering on the System.....	12
Installing the Backup Software.....	13
Chapter 3: Equipment Description.....	15
Front Panel Switches and Indicators.....	16
Rear Panel Switches and Connectors.....	18
Main Menu Items.....	18
Configuration Menu.....	20
Buzzer Configuration.....	20
SCSI ID Config.....	21

SCSI Parity	22
Off-Line Time.....	22
Drive Configuration.....	23
On-Line Mode.....	23
Sequential-Access Mode Configuration.....	24
Diagnostics Menu.....	25
Write EEPROM Mode	26
Chapter 4: Operation and Maintenance	27
AIT Media.....	28
Inserting the Data Cassettes into the Magazine	29
Inserting the Magazine into the VLS.....	30
Loading the Magazine	32
Attempting to Load the Magazine with a Cassette Already in Drive	33
Removing the Magazine from the VLS.....	33
Removing the Magazine while a Cassette is in the Drive.....	35
Loading an Individual Cassette.....	36
Manually Removing a Cassette Loaded in the Drive	36
Removing a Cassette from the Magazine	37
Storing the Magazine.....	38
Cleaning the Drive Head.....	38
Cleaning the Enclosure	42
Chapter 5: Troubleshooting and Diagnostics	43
VLS Error Messages.....	44
Error Messages.....	44
Drive Warning Signals.....	46
LED Indicators	47
Environmental Considerations.....	50
When You Call <i>adic</i> Customer Assistance	50
Return for Repair RMA (Return Merchandise Authorization)	51
Appendix A: Installing the Ferrite Bead.....	53
Appendix B: Diagnostics Menu.....	55
Appendix C: Downloading New Firmware	63
Appendix D: Glossary	65
Appendix E: Specifications	69
Index	73

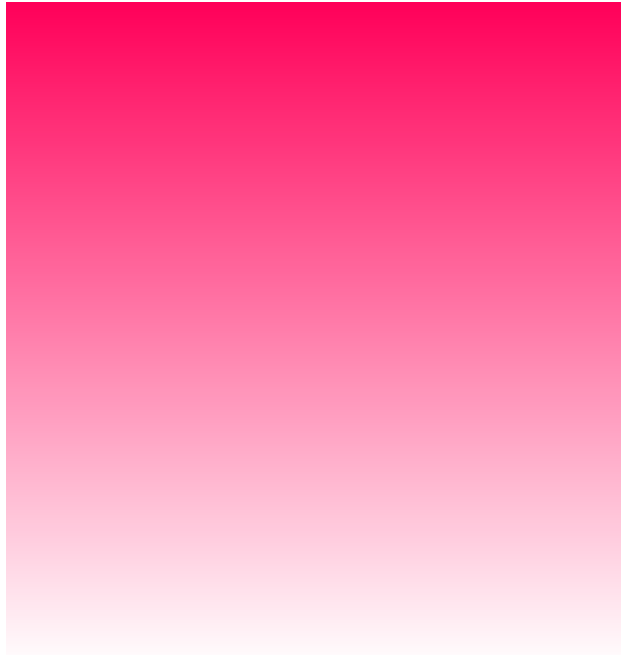

Quickstart

- provides a quick start guide for experts who are familiar with installing computer hardware and software.

- Confirm that power is off and that you have a SCSI interface (either a separate board as offered by *adic* or integrated on the mother-board) installed in the host computer. Consult your computer manual.
- Place the *adic* VLS near the host computer to which it will be connected.
- Connect the SCSI interface cable between the SCSI connectors on the computer and the back of the VLS.

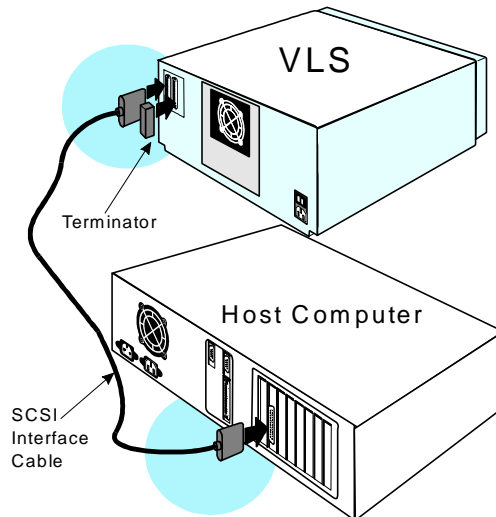

Make sure there is a terminator installed on the last device of the SCSI chain.

Note

adic recommends using the 68-pin fast/wide terminator such as *adic* p/n 61-1138-01.

- Connect the AC power cord first to the VLS and then to the AC outlet. Power on the VLS. Power on the host computer.

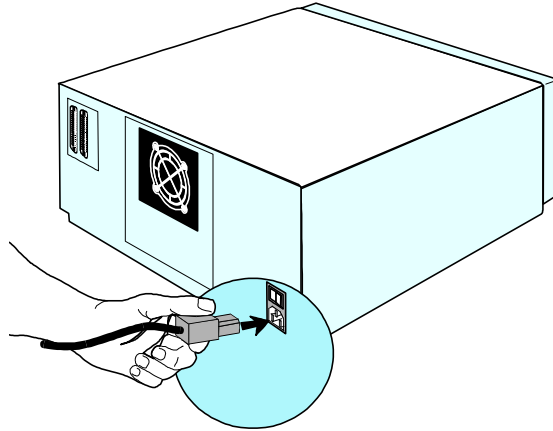

- ❑ Place the magazine on the carriage by slipping it over the left “magazine” and then rotating toward the right and pressing into place on the right “magazine position” pin.

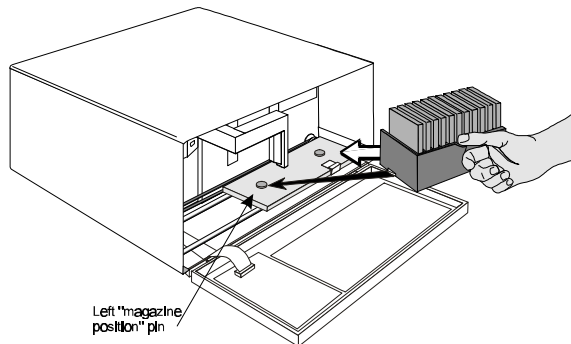

- ❑ If the application has not already done so, load the magazine by pressing first the **ALT** button and then the **LOAD** button. (If you are in sequential mode, the first cassette will be inserted in the drive when the load finishes.)

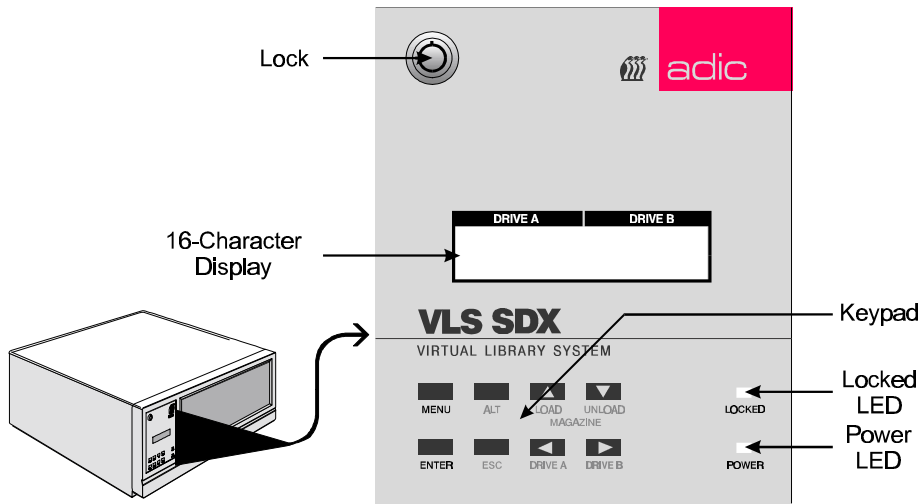

- Install or confirm the backup software (to run the VLS) on the host computer.
- Run any diagnostic tests provided with the backup software to make sure the VLS is communicating correctly with the host computer.

You are now ready to run the VLS at a system level.

Chapter 1

Getting Started

This Chapter...

- ❑ covers what you need (and what you need to know) to install the `adlc` Virtual Library System. Read this section before you begin installation.

Introduction

adic has designed the Virtual Library System (VLS) for high-capacity, near and off-line storage applications, such as backup, hierarchical storage management (HSM) and video/design/data file libraries. For the most part, installation is simply a matter of checking all necessary SCSI connections, installing the software (backup or otherwise) and applying power. The defaults set at the factory should be sufficient for most applications.

Requirements

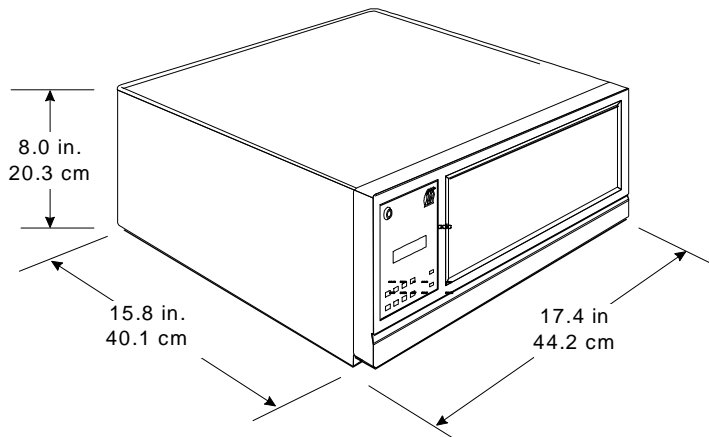

- ❑ Space requirements: the VLS has a footprint of 17.4" x 15.8". You must allow adequate clearance to the rear (2 inches or more) and bottom (do not place on carpeting) to allow air flow. Also allow enough room at the front to open the door (which is 8" high and hinged at the bottom).
- ❑ Host computer system: We assume that you are familiar with your computer system. The VLS must be integrated with the host computer system. The backup software, SCSI host adapter (if required) and any additional, or different, SCSI interface cables must be purchased separately.
- ❑ Mode of operation: You must know whether the VLS will be operating in sequential-access or random-access mode. This will be determined by the backup software you use.

-
- ❑ Necessary tools: No special tools are required to install the VLS. If you are installing a SCSI host adapter at this time, refer to the installation manual for your host adapter.

Unpacking and Inspecting

Caution

If the operating environment differs from the storage environment by 15° C (30° F) or more, let the unit acclimate to the surrounding environment for at least 12 hours.

- ❑ Unpack all items from the carton. Save the packing materials in case you need to move or ship the system in the future.

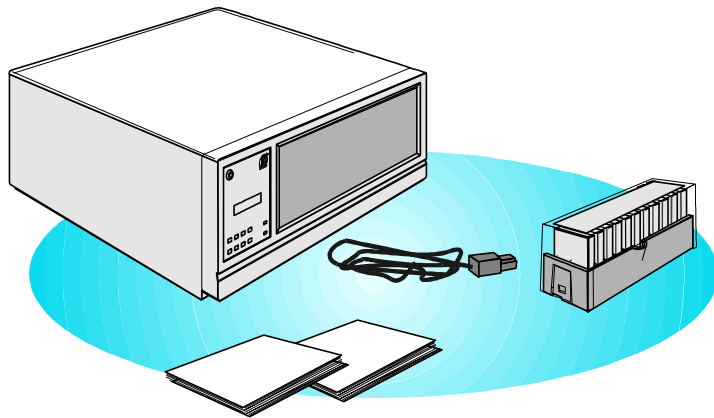

Caution

You must ship the entire VLS in the original or equivalent packing materials or your warranty may be invalidated.

Equipment Description

The VLS Unit

The adic VLS is a fully automated, high performance, high capacity, mass storage system designed with a removable data cassette magazine. The door can be locked to deactivate the unit's keypad, assuring only authorized removal of the magazine and media. In addition, to protect the unit, data and media, the VLS will not operate unless the door is closed.

Magazine

Caution

Do not attempt to use 8mm media (such media can damage the head and tape handling parts – voiding your warranty).

The magazine for the VLS holds eleven AIT cassettes. It includes a clear dust cover to protect the cassettes and for ease of storage. Figure 1 shows an AIT cassette and a filled magazine with the cover in place.

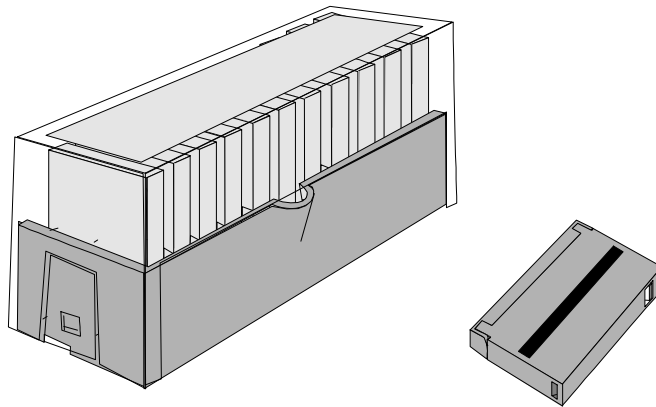

Figure 1. VLS Magazine with AIT Cassettes

Media

The VLS SDX uses AIT data cassettes. Before inserting the cassette into the magazine check the position of the write-protect switch. Set all switches to the enabled position (unless a tape contains data that you don't want erased) – refer to Figure 2. (The write-protect switch enables or disables the ability to write [or delete] files on the data cassette.)

To write-protect the data cassette, move the write-protect switch away from the edge of the data cassette, as shown in Figure 2. If the red tab is visible, the cassette is write protected and cannot be written to (or erased).

To write-enable the data cassette, move the write-protect switch toward the edge of the data cassette, as shown. If the red tab is not visible, the data cassette is write enabled and can be written to or erased. Use a ball-point pen or similar instrument to set the write-protect switch.

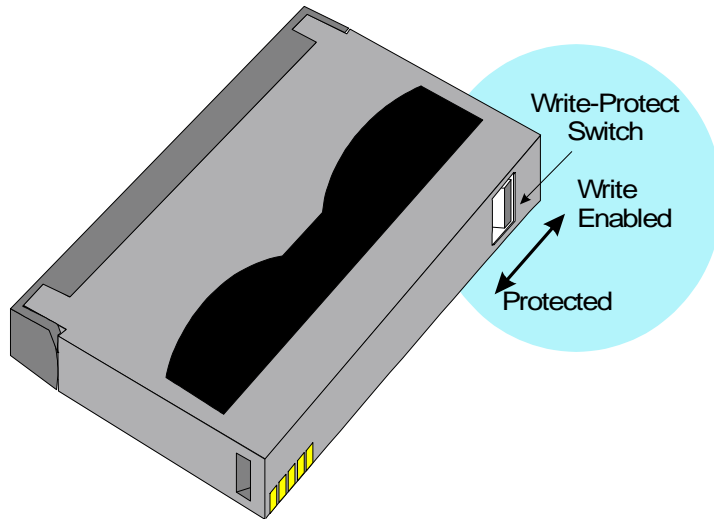

Figure 2. AIT Cassette Showing Write-Protect Switch

Cleaning Cassette

The tape head should be cleaned once a month *or* when the Cleaning Request message appears on the drive front panel Status LED (see *Troubleshooting and Diagnostics*). A Sony SDX-TCL cleaning cassette is shipped with your *adic* VLS. Discard it after approximately 70 uses and replace it with the same or equivalent type cassette. See *Cleaning the Drive Head* later in this manual.

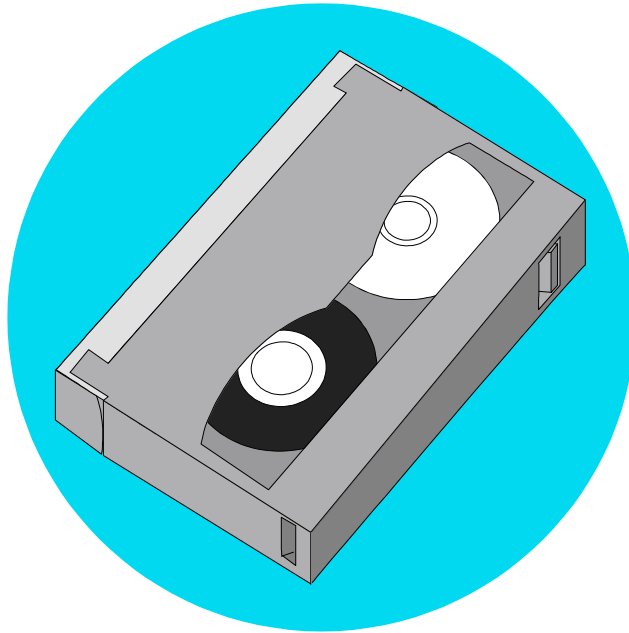

Figure 3. AIT Cleaning Cassette

System Software

A variety of backup and data storage software is available for use with the VLS. Please check with *adic* sales or Customer Assistance if you have a question on the compatibility of a particular software package.

Preparing the Host Computer System

Power Off the Computer

- Turn off the power switch
- Unplug the cord from the AC outlet.

Confirm and/or Install the SCSI Host Interface

Note

The VLS SDX must be connected to a SCSI-2 Fast/Wide host adapter.

The VLS must be connected to either an integrated SCSI host or a SCSI host adapter installed in the computer – either directly to the I/O connector on the card or as part of an existing SCSI chain. The SCSI interface must be installed before you connect the VLS. Refer to the instructions supplied with your selected SCSI interface.

Now you are ready to connect the VLS to your host computer. Follow the instructions provided in the next chapter.

Note

The host computer system normally is the server.

Blank Page

Chapter 2

Connecting the VLS

This Chapter...

- provides instructions for physically connecting your VLS to your host system.
- steps you through the final phase of the installation process.

Connecting the Interface Cables

Note

The interface cables must be shielded – *adic* can supply you with the correct type(s).

Make sure the interface cable you are using has the appropriate connectors on each end. If the host computer's SCSI connector is different from that on the VLS, you will need to obtain a different cable than the one supplied with the unit. Consult your dealer or *adic* Customer Assistance if you need help. Connect the interface cables as shown in Figure 4 and explained in the following steps:

- Check that the power switches on both the VLS and the host computer are off.
- Attach one end of the SCSI interface cable to either connector on the rear of the VLS. Press firmly and secure the jack screws.

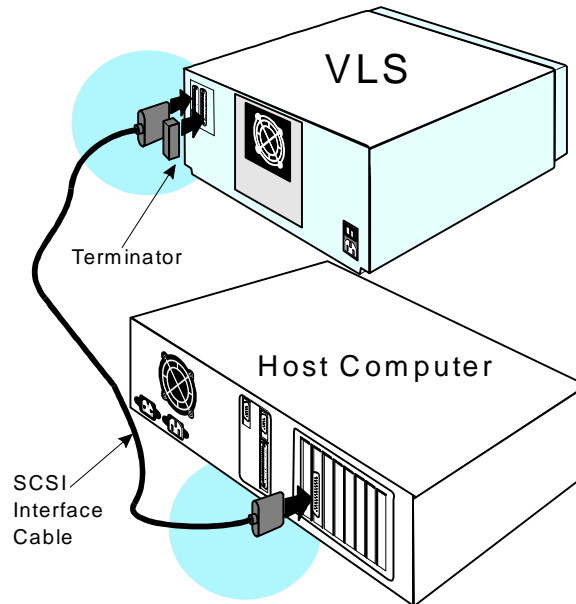

Figure 1. Connecting the Interface Cables

Note

The jack screws at both ends of the SCSI cable must be securely fastened in order for the VLS to communicate properly with the computer.

- ❑ Plug the other end of the SCSI interface cable into the external connector on the SCSI port card. Secure firmly.
- ❑ If this is the only unit you are installing, insert an external terminator plug into the second SCSI connector at the rear of the VLS. If you plan to connect another unit on the same SCSI channel, see the next section.

Connecting More Than One VLS

If you are connecting additional VLS units on the same SCSI channel, simply attach each subsequent unit to the previous unit with an interface cable. Make sure all cables are properly secured. You can attach up to fifteen devices on each SCSI-2 Fast/Wide channel.

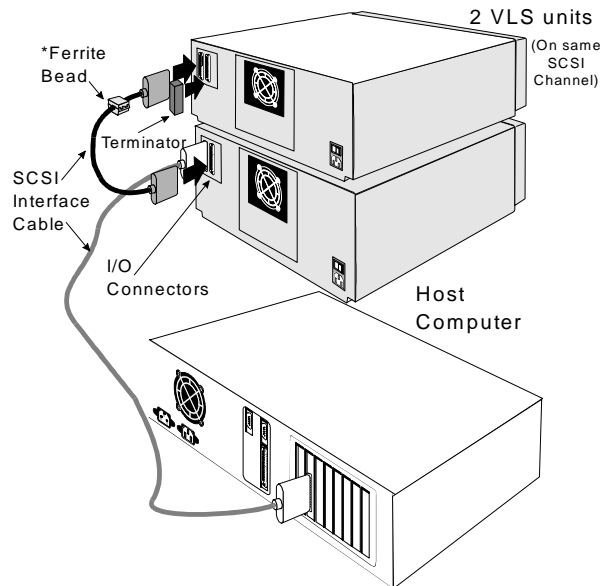

Figure 2. Cable Diagram for two VLS Units

Note

* When connecting two or more VLS units to a single SCSI channel, you must install a ferrite bead on the cable. Refer to Appendix A for details.

Each VLS unit contains more than one SCSI device and may require more than one SCSI ID (depending on the mode of use and number of drives). The first chart below shows various configurations and the number of SCSI IDs required. The second chart illustrates how many VLS units you can attach to one SCSI channel (if there are no other devices on the channel).

Note

When counting SCSI devices, keep in mind that a VLS can contain up to three devices (Drive A, Drive B and the robotics). Don't forget to include in your count other devices on your SCSI channel (i.e., a tape unit, an additional hard drive, etc.).

	Number of SCSI IDs Required	
VLS	Sequential Mode	Random Mode
One drive	1	2
Two drives	N/A	3

	Maximum VLS units on one Channel	
VLS	Sequential Mode	Random Mode
One drive	15	7
Two drives	N/A	5





Powering on the System



- Plug the power cord into the back of the VLS.
- Plug the power cord from the VLS into a grounded electrical outlet.
- Plug the power cord from your host computer into a grounded electrical outlet.

-
- ❑ Turn on the VLS power. Turn on the host computer power.

A display similar to the following will appear on the VLS display:



The top line of the LCD is logically divided into a Drive A side (left), and a Drive B side (right). When the VLS is in the On-Line mode, the LCD displays the current status of the drives on the top line. The  symbol indicates that the drive is configured, on-line, and is aligned with the Media Picker. The  symbol indicates that the drive is configured and on-line, but is not aligned with the Media Picker. The  symbol indicates that there is no *configured* drive in that position. The  in the 5th character position for each drive indicates that the VLS does not know if a cartridge is currently loaded in that drive. If the VLS had loaded a cartridge into a drive prior to shut-down, this character and the one proceeding it would reflect the slot number of the magazine that the cartridge was loaded from (01 to 15). The 7th character position may display a  symbol, indicating that the drive is actively writing or reading.

The bottom line of the LCD, when the VLS is in the On-Line mode, displays the current status of the magazine. The   characters indicate that the VLS does not know the current status of the magazine. This is normal immediately following power-up. If the magazine had been loaded prior to shut-down, the VLS would display  when repowered..

You are now ready to install the backup software – if it has not already been installed.

Installing the Backup Software

At this point you need to refer to your software installation guide for instructions on installing the backup/controlling software for the VLS onto the host computer.

After you have completed installation of the VLS and the backup/controlling software, make sure that your unit is operating correctly by running any diagnostic test(s) supplied with the backup software.

Blank Page

Chapter 3

Equipment Description

This Chapter ...

- describes the switches, indicators and connectors on the front and rear of the VLS.
- describes the various functions available via the front panel buttons.
- describes the power-up procedure and messages on the front panel LCD display.

Once your VLS has been connected to your host computer system and the software has been installed, the VLS is ready for use. Just turn on the power switch, place a magazine on the carriage and press **ALT** and then **LOAD**.

Note

This is the software that runs the VLS, not the data being transferred to the VLS cassettes. Two examples of backup software are Cheyenne's ARCserve and Legato's NetWorker.

If you need to change certain operating functions, you can use the front panel buttons (as described in the next section).

Front Panel Switches and Indicators

Switches and indicators on the front of the VLS are shown in Figure 6.

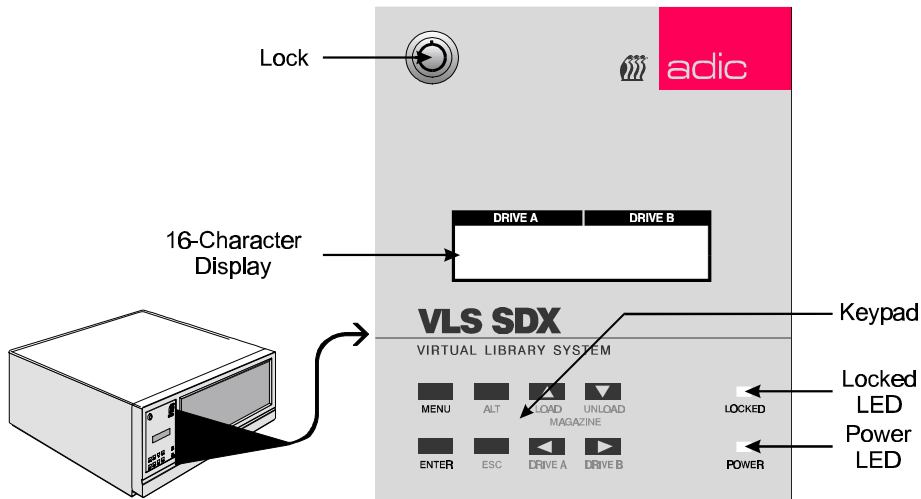







Figure 6. Front Panel Display and Keypad

Lock In the locked position, you cannot open the door to the VLS or access any functions of the keypad.

Display The two-line 16-character LCD display shows current drive status, and displays error messages.

Power LED (green)	Lights when power is on.
Locked LED (green)	Lights when door is locked. The magazine, drive, and keypad cannot be accessed while the locked LED is on.
MENU	Press this button to enter or exit Off-line Mode menus.
ALT	Selects alternate function for another button. For example, press the ALT button and the UP  button to activate the load function.
Up 	Selects previous item or value in the menu.
LOAD	Press the ALT button and then this button to initiate a "load magazine" – the VLS will check all cassettes in the magazine (making note of empty spaces) and that all cassettes can be inserted in the drive.
Down 	Selects next item or value in the menu.
UNLOAD	Press the ALT button and then this button to initiate the unload program – the VLS will return the magazine to the unload position.
ENTER	Selects currently displayed item.
ESC	Exits current menu and returns to previous menu.
Left 	Scrolls message display to the left or selects previous field on same line.
DRIVE A	Press the ALT button and then this button to select drive A.
Right 	Scrolls message display to the right or selects next field on same line.
DRIVE B	Press the ALT button and then this button to select drive B.

Rear Panel Switches and Connectors

Switches and connectors on the rear of the VLS are shown in Figure 7.

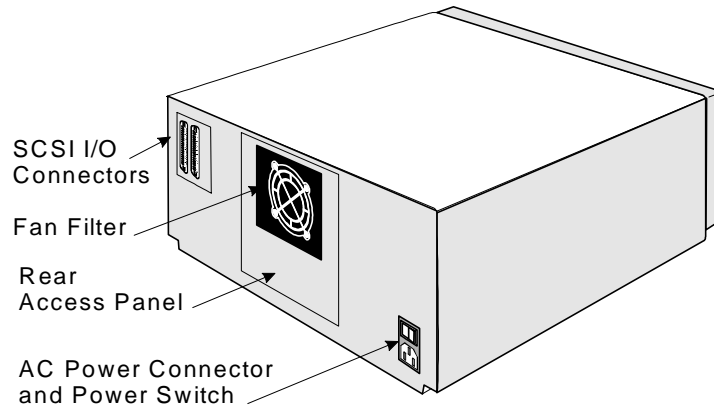
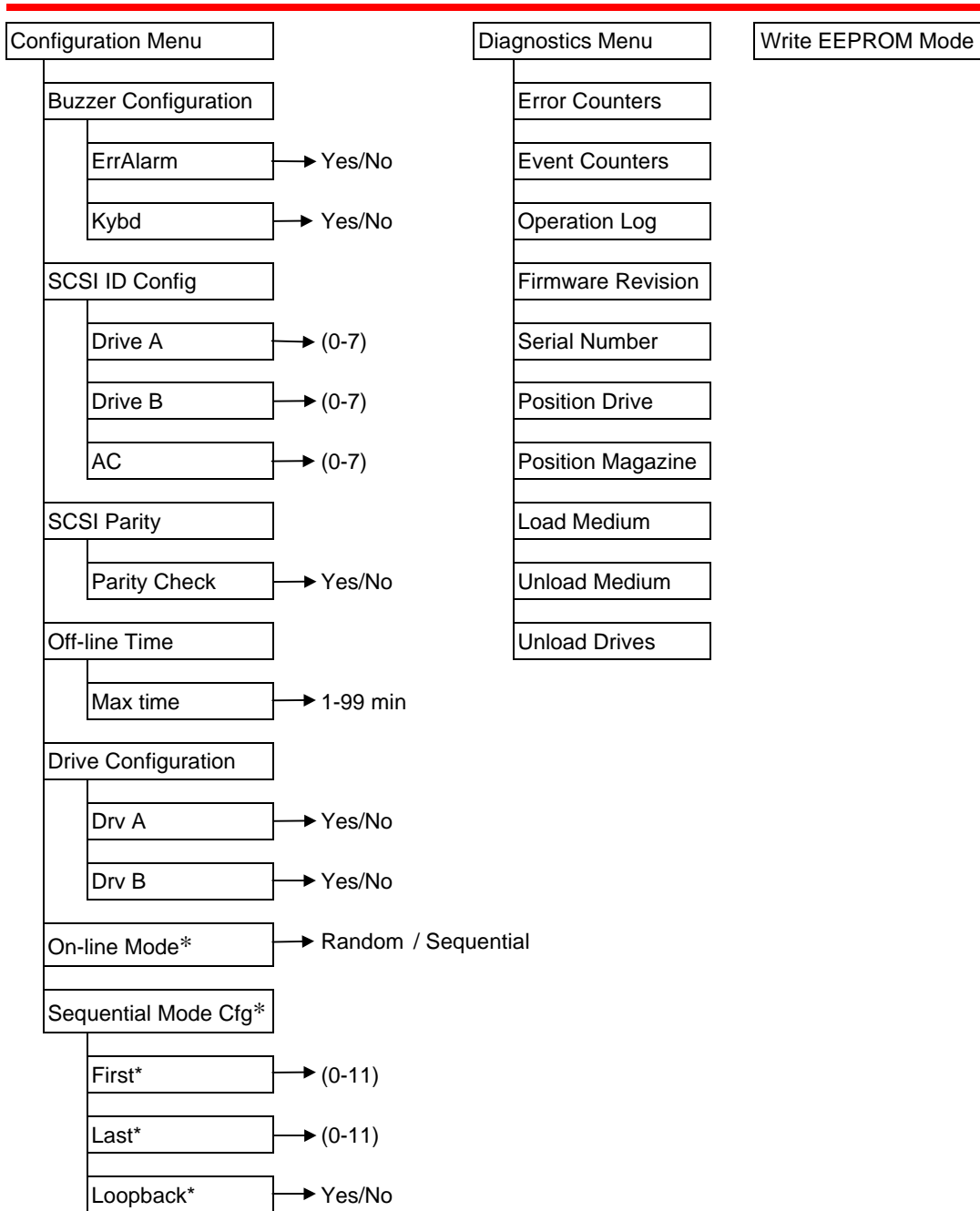

Figure 7. Back of adic VLS

Power Switch	Turns on the AC power to the VLS.
AC Power Connector	Plug the AC power cord into this connector.
SCSI I/O Connectors	Connections for the cable which connects the VLS to the host computer, to other VLS units and/or to other devices on the SCSI channel.

Main Menu Items

Use the following diagram as a quick reference once you have become familiar with the LCD menus described on the next few pages. The names at the top of the diagram are selections available from the Main Menu. When you choose one of the Main Menu items, a set of options appears; these options are listed below the Main Menu selections. If an option has sub-options, these sub-options are listed to the right of the option.







*Available only when VLS is configured as a single-drive unit.

To access the Off-Line menu, press the **MENU** button. The display will appear as follows:



```
OFF-LINE MENU
Config Menu  ▸
```

Use the **UP**  or **DOWN**  buttons to scroll through the menu. Press **ENTER** to select a displayed item. Use the **RIGHT**  or **LEFT**  buttons to scroll through fields on the same line.

To exit the Off-Line menu press the **MENU** button.

Configuration Menu

The Configuration Menu allows you to select the following operating parameters:

- Buzzer Configuration
- SCSI ID Configuration
- SCSI Parity
- Off-Line Time
- Drive Configuration
- On-Line Mode (Single Drive models only)
- Sequential-Access Mode Configuration (Single Drive models only)



Buzzer Configuration



Enables/disables the sounding of an alarm when an error message is displayed.
Enables/disables the beep sound when you press a keypad button.

When you select the Buzzer Configuration option a display similar to the following appears:



```
BUZZER CONFIG
ErrAlarm:N Kybd:
```

To enable the error alarm use the **LEFT**  button to select the ErrAlarm field. Use **UP**  or **DOWN**  to select "Y" to enable alarm or "N" to disable alarm. When Error Alarm mode is enabled, a continuous alarm tone will sound in the event of an error message. The alarm will sound until the condition that caused the error has been removed or any key is pressed. To clear an error message from the display, press **ALT** and **ENTER**.

If you wish to change the status of the keyboard beep, use the **RIGHT**  button to select the Kybd field. Use **UP**  or **DOWN**  to select "Y" to enable a beep when you press a button or "N" to disable the beep. Press **ENTER** to make the changes effective or press **ESC** to return to previous menu item.





Note

Buzzer Configuration default: Err Alarm: N, Kybd: Y

SCSI ID Config

Lets you select the SCSI ID for drive A, drive B and the robotics on the VLS.

```
SCSI ID CONFIG
DA:1 DB:2 AC:3
```

Use **LEFT**  or **RIGHT**  to select the desired field. DA is Drive A, DB is Drive B and AC is the robotic unit (autochanger) on the VLS. Use **UP**  and **DOWN**  to scroll to the desired ID for that particular element. Press **ENTER**.

Notes

SCSI ID changes entered do not take effect until you cycle power on the VLS unit.



SCSI ID Configuration default: Drive A:1, Drive B:2, AC:3

See the section in Chapter 2 noting the SCSI IDs needed for the VLS.

SCSI Parity

Lets you enable or disable the reporting of SCSI parity. Press **ENTER** to access this function.

```
SCSI PARITY
Parity Check:N
```

Use **UP**  or **DOWN**  to select "Y" to enable the reporting of parity check or "N" to disable the reporting of parity check. Press **ENTER** to activate the change.



Note

SCSI Parity default: Parity Check: N

Off-Line Time

Lets you set the number of minutes the VLS will remain in the Off-Line mode. If someone leaves the VLS in an Off-Line mode, after the pre-set number of minutes the VLS will automatically return On-Line. This assures that your automatic backup will be done even if the VLS has accidentally been left Off-Line.

```
OFF-LINE TIME
Maxtime:5 min
```

Use **UP**  or **DOWN**  to select the number of minutes you wish the VLS to remain Off-Line. Press **ENTER** to execute the change.





Note

Off-line time default: "5" minutes.

Drive Configuration

This function lets you enable or disable which drives are on-line.

```
DRIVE CONFIG
Drv A:Y Drv B:Y
```

Use **LEFT**  or **RIGHT**  to select the drive you wish to change. Use **UP**  or **DOWN**  to select "Y" to put the drive on-line or "N" to disable the drive. If you have only one drive installed, you cannot access the Drv B field.

Note

A disabled drive is still connected to the SCSI bus and will respond to the last address setting. To assure that address changes and drive configuration changes are fully initiated, you must cycle power.

Disabling both drives is not allowed (setting "N" in Drv A or Drv B field automatically places "Y" in the other field).

Note

Drive Configuration default setting is "Y" for each installed drive.

On-Line Mode

Lets you select random-access or sequential-access operating mode.



When used in random-access mode, the VLS allows software selection of *any* cassette in the magazine in *any* order. You can logically divide cassette usage to satisfy particular data storage needs. For example, you can assign one or more cassettes to specific data functions (such as certain directories or network servers), or you can assign specific cassettes to individual users.

Note

If you have both drives on line, you will not be able to access this function. The software you use with the VLS determines whether you can operate the VLS in sequential and/or random mode.

edic's VLS can also be used as a stacker in sequential-access mode if your software does not support the random-access mode function.

```
ON-LINE MODE
Mode: RANDOM
```

Use **UP**  or **DOWN**  to select "random" or "sequential".

Note

Operating Mode default setting is "Random".



Sequential-Access Mode Configuration

If you are using Sequential-Access Mode, this option lets you select which cassettes the drive will write to, and whether or not you wish the drive to start again at the beginning after the last cassette has been written to.

Note

If you have a dual-drive system and both drives are on line, you will not be able to access this function.

```
SEQ MODE CFG
F:01 L:15 Lpbk:Y
```

Use **LEFT**  or **RIGHT**  to select the item you wish to change. "F" is the number of the First cassette you wish the VLS to insert into the drive. "L" is the number of the Last cassette you wish the VLS to insert into the drive.

The Loopback (LPBK) mode determines what happens when the last cassette has been filled. If you select "Y" for "Lpbk" the designated first cassette will be loaded into the tape drive after the last cassette has been filled and ejected. If you select "N" an error message will be issued and the backup will stop.

Note

Default setting is F: 01 L: 11 Lpbk: Y

Diagnostics Menu

```
OFF-LINE MENU
Diag Menu      ▾
```

The following functions are available under the Diagnostics Menu:

- Error Counters
- Operation Log
- Serial Number
- Position Magazine
- Unload Medium
- Event Counters
- F/W Revision
- Position Drive
- Load Medium
- Unload Drives

For information on these options, refer to Appendix B.

Warning

We highly recommend that these diagnostic functions be used only by a qualified service technician (or on the instruction of a qualified technician). Some of these functions assume that the unit has been set up correctly and thus many of the normal built-in safety checks are turned off. Misusing these diagnostic functions without the normal safety checks could result in improper operation (or even damage to media or VLS).

Write EEPROM Mode

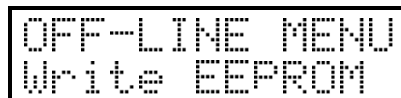

```
OFF-LINE MENU  
Write EEPROM
```

The Write EEPROM Mode is used whenever you upgrade the VLS firmware. Refer to Appendix C in this manual for additional information.

Chapter 4

Operation and Maintenance

This Chapter ...

- describes normal operation features of the VLS.
- provides details on the media and magazine
- explains normal maintenance procedures.

The VLS is a highly sophisticated unit composed of one or two drives along with the electro-mechanical robotics that control the drive(s), magazine media. No modifications have been made to the drive(s). The built-in drive warning LEDs function as the manufacturer has specified.

Very little routine maintenance routine is required – apart from cleaning the heads once a month, or when the Cleaning Request message appears on the drive front panel Status LED (see “*Cleaning the Drive Head*” later in this manual).

Also refer to “*Cleaning the Fan Filter*”.

Note

Since the drive status LEDs are located on the lower front of the drive, to see them you must be eye-level with the gripper arm of the VLS. Look beyond the arm to the drive.

AIT Media

Use only Sony AIT data cassettes with the VLS SDX. These data-grade cassettes are manufactured under more stringent environmental, reliability and durability specifications than video-grade cassettes, producing superior data reliability.

Caution

Do not attempt to use 8mm media. 8mm data cassettes are not compatible with the SDX-300C drive.

A write-protect switch is used to prevent recording over existing data. To prevent recording or deleting, place the write-protect switch to the open position. The drive senses the position of the switch and will not allow writing in this position. When inserting cassettes in the magazine, place the switch in the closed position (unless you do not wish to record on a specific cassette).

Inserting the Data Cassettes into the Magazine

The magazine for the VLS SDX holds eleven AIT cassettes. It includes a clear dust cover to protect the cassettes and for easy storage. See Figure 8. Insert each cassette into a slot of the magazine making sure that the write-protect switch is toward the *bottom*, facing the closed side of the magazine (as illustrated).

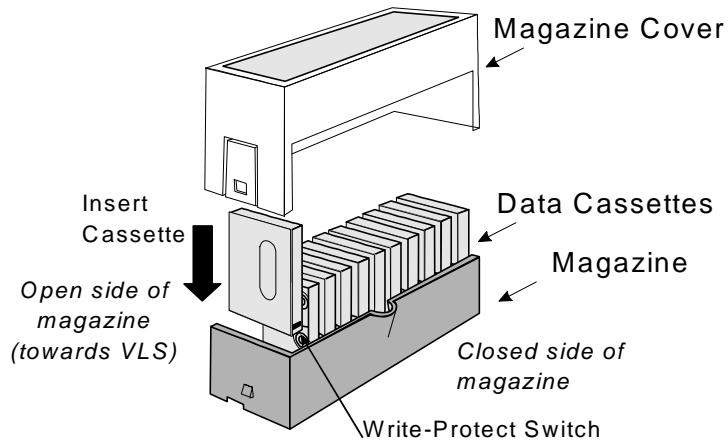

Figure 8. Magazine for VLS

The open side of the magazine faces the VLS. Make sure each cassette touches the bottom floor of the magazine.

Do not use wrap-around labels on the individual cassettes. Most labels use a removable adhesive and have a tendency to curl or tear after multiple uses. This can jam the movement of the VLS. Place labels only in the space provided on the cassette.

Note the following:

- Store magazines (and data cassettes) in a dry, cool environment. Keep the dust cover on the magazine.
- Never reset or power down your computer or VLS while a function is in process or a tape is moving. In addition to getting tape with missing or corrupted data, you may also get tape run-on within the drive (a condition that can produce internal contamination requiring factory cleaning).

-
- If a power outage occurs during a back-up sequence, restart your backup from the beginning.

Note

Be very careful when handling the magazine. The cassettes can fall out once the cover has been removed.

Inserting the Magazine into the VLS

Note

Do not attempt to place a covered magazine onto the VLS carriage.

- Remove the magazine cover. You can remove the cover by pressing the middle of both ends (where it is labeled PUSH) and lifting up (see Figure 9).

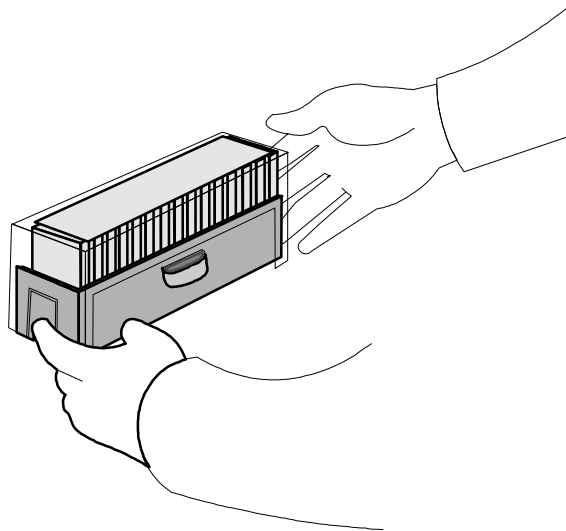

Figure 9. Removing the Magazine Dust Cover

- Open the VLS door. (The pick arm must be in the "out" position before you try inserting a magazine.)

-
- ❑ Holding the magazine by the thumbhole handle, and at a 45° angle to the carriage, slip the magazine onto the left side of the carriage, over the magazine position pin (see Figure 10).

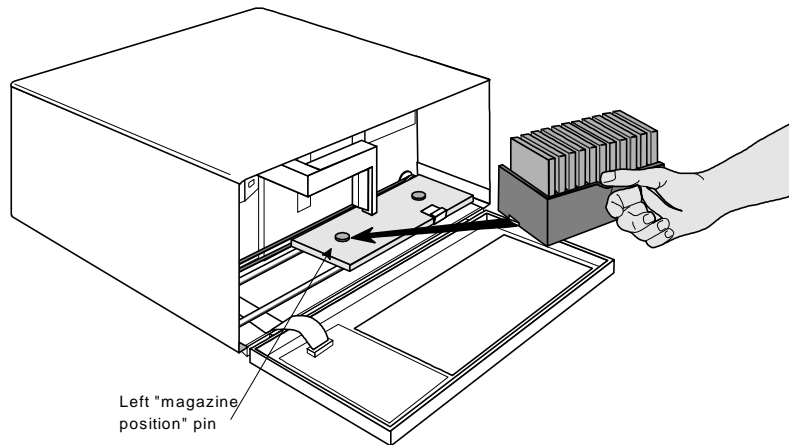

Figure 10. Placing the Magazine onto the VLS

- ❑ Push the right side of the magazine over the right hand magazine position pin until you hear a click. See figure 11.

Note

You may need to apply downward pressure as you slip the magazine over the right magazine pin, and then press the magazine into place with your index finger.

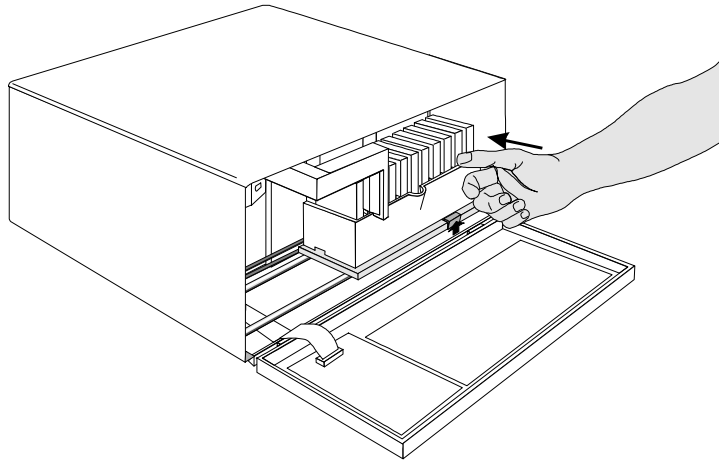

Figure 11. Pushing the Magazine in Place

The magazine will snap into place. If you don't hear a click, make sure that the slot on the right side of the magazine has slipped around its magazine position pin and is not just sitting on top of it (the magazine will not load correctly in this position).

Loading the Magazine

Once you have placed the magazine on the carriage, the VLS must initiate a loading process. During this procedure the VLS checks and maps the position of each cassette and makes sure that all cassettes are inserted into the magazine correctly. If you are using the sequential mode the VLS inserts the first cassette into the drive.

Note

The door must be closed before the LOAD or UNLOAD functions will activate.

- Make sure the magazine is placed correctly on the carriage.
- Close the door and press **ALT** and then **LOAD**. The VLS will initiate the load magazine procedure.

Note

In the sequential mode, if you press **UNLOAD** before the VLS has finished loading the magazine, the robotics will finish mapping and checking the cassettes and then move the magazine to the unload position (the far right) without inserting a cassette into the drive.

In random mode, if you press **UNLOAD** before the VLS finishes loading the magazine, it will have no effect.

Attempting to Load the Magazine with a Cassette Already in Drive

Random-Access Mode: If the cassette was loaded manually, it must be unloaded manually – before you attempt to have the VLS load the magazine. Refer to the next section for manual removal of a cassette. If the VLS robotics was used to load the cassette via applications software, attempting to "load magazine" from the keyboard will fail – the unit will remain on-line.

Sequential-Access Mode: If the cassette was loaded manually, it must be unloaded manually – before you attempt to have the VLS load the magazine. Refer to the next section for manual removal of a cassette. If the VLS robotics was used to load the cassette, the VLS will remember and not allow a "load magazine" from the keyboard. Press **ALT** and then **ENTER** to bring the VLS back on-line.

Removing the Magazine from the VLS

Before physically removing the magazine from the carriage, you must first initiate the UNLOAD procedure.

- Make sure there is no cassette in the drive. If there is, go to the next procedure, *Removing the Magazine with a Cassette in Drive*.
- Press **ALT** and then **UNLOAD** and wait until the unload procedure is finished. (If the carriage is not in the unload position, it will move to the right. In addition, the grippers on the pick arm will close.)

Note

You cannot initiate an (UNLOAD), or remove the magazine, if the door is locked. When the locked light is on, the VLS ignores the LOAD and UNLOAD buttons.

- ❑ Press the Magazine Release on the carriage. See Figure 13. The magazine will release from the holding pins.

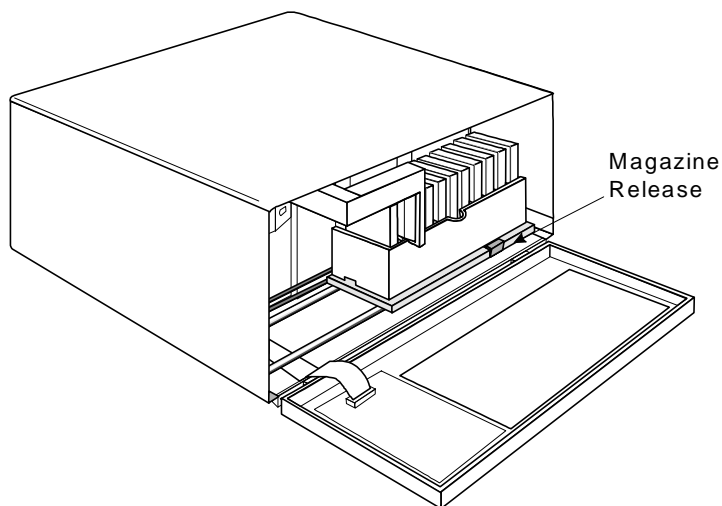

Figure 13. The Magazine Release

- ❑ Grab the thumb handle on the magazine and pull the right side of the magazine toward you. The magazine will come out at a 30-40 degree angle.
- ❑ Place the transparent cover over the magazine and store the unit in a cool, dry place.

Note

Make sure you have labeled each cassette as to magazine and slot number. If you tip or drop the magazine without the cover on, the cassettes will fall out.

Removing the Magazine while a Cassette is in the Drive

- Press **ALT** and then **UNLOAD**. This will place the magazine in the unload position.
- Open the VLS door. Remove the magazine from the carrier.
- Press the eject button on the drive (see Figure 12). It may take 30 seconds or more for the drive to eject the cassette.

If you wish to remove the magazine but there is a cassette in the drive, do the following:

- Open the VLS door.
- Press the eject button on the drive (see Figure 12).
- Close the door of the VLS. It will take about 30 seconds for the drive to unload the tape.
- Press **ALT** and then **UNLOAD**. The arm will return the cassette to the magazine slot and the VLS will move the magazine to the unload position.
- Remove the magazine as noted earlier.

Loading an Individual Cassette

If for some reason you need to use a single cassette, you can load it manually (this operation is the same as when loading a cleaning cassette).

- Unload the magazine by pressing **ALT** and then **UNLOAD**. The magazine will move completely to the left.
- Open the door and remove the magazine from the carriage. (See previous instructions)
- Insert the cassette into the drive opening with the label side to your right and the write-protect switch down. The drive will take approximately 20 seconds to load the cassette.
- Close the door and initiate desired program.
- If the drive does not eject the cassette when the program is finished, open the VLS door (the gripper arm should still be fully extended) and press the drive eject button (refer back to Figure 12 if necessary). It will take about 30 seconds for the drive to eject the cassette.

Manually Removing a Cassette Loaded in the Drive

- Press **ALT** and then **UNLOAD**. This will place the magazine in the unload position.
- Open the VLS door. Remove the magazine from the carrier.
- Press the eject button on the drive (see Figure 12). It may take 30 seconds or more for the drive to eject the cassette.

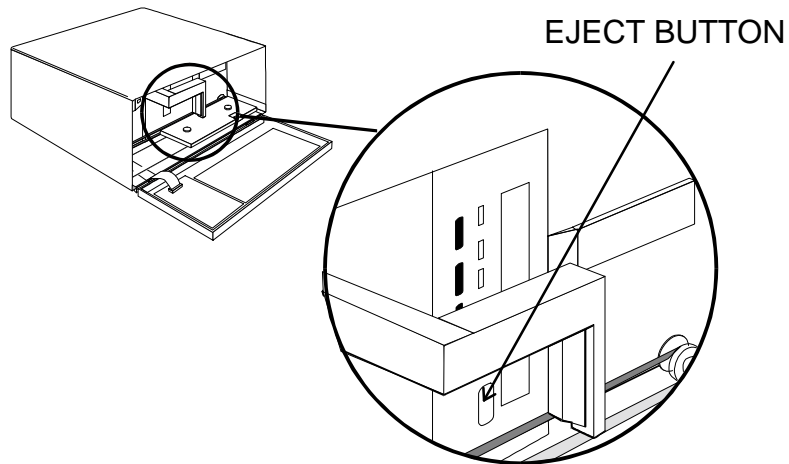

Figure 12. Drive Eject Button.

Note

You must be eye-level with the gripper arm of the VLS to see the drive Eject Button and LEDs, which are located on the left side, bottom and top. Look beyond the arm to the drive.

- Remove the cassette manually.
- Place the magazine back onto the carriage.
- Close the door. You can now initiate the load procedure.

Removing a Cassette from the Magazine

The data cassettes easily slip into and out of the slots of the magazine. To remove a cassette, simply grasp it with two fingers and pull up. Make sure each cassette is labeled so you know the contents (and where it belongs in the magazine sequence).

Remember – Do not use wrap-around labels on the individual cassettes. Most labels use a removable adhesive and have a tendency to curl or tear after multiple uses. This can jam the movement of the VLS. Place labels only in the space provided on the cassette.

Storing the Magazine

Store magazines in a dry, cool environment. Always keep the dust cover on the magazine.

The removable magazine allows for long-term archiving or off-site safety storage of groups of cassettes.

You can duplex multiple VLS units so your system can mirror data backups on each separate unit. With duplexing you have real time data assurance and the ability to remove one magazine for off-site storage while the other remains for on-line data access.

Cleaning the Drive Head

Caution

Using cloth swabs, cotton swabs, or cleaning agents may void the warranty. Use only a Sony SDX-TLC cleaning cassette.

Clean the drive head and tape path once a month, or when the Cleaning Request message appears on the drive front panel Status LED. This cleaning frequency does not depend on the format in which you write and read data. However, if you are using the VLS in a particularly dirty environment, or if you operate it infrequently, we suggest that you clean it more often.

As a visual reminder, the drive LEDs will display the Media Caution indication during cassette load/unload operations after approximately 30 hours of tape motion since the last cleaning. The left and right LEDs (on the drive) will flash rapidly and the middle LED will flash irregularly. To see the drive LEDs, you must open the VLS door and look at the drive (see Figure 14). We urge you to clean the drive as soon as possible after the LEDs begin flashing.

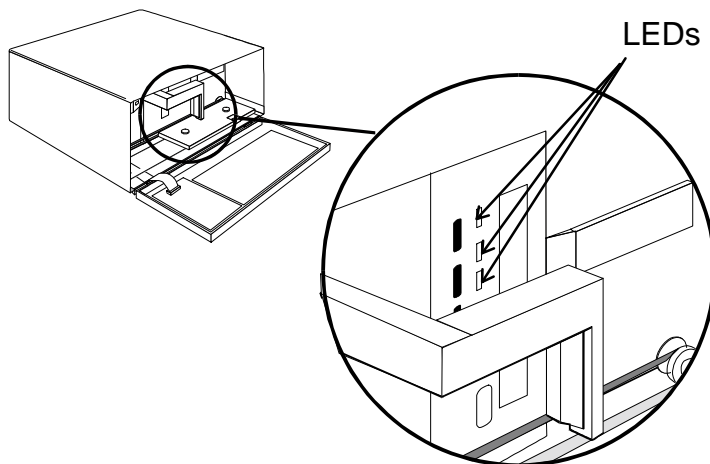

Figure 14. Position of Drive LEDs

Caution

To prevent contamination of the drive and damage to the head, do not use the cleaning cassette for more than the number of cleaning cycles specified on the cassette label. Discard the cleaning cassette after you have used it the specified number of cleaning cycles. ***Do not attempt to rewind the material in the cleaning cassette and reuse it.***

Please follow these cleaning directions carefully to assure that no damage will occur to the drive, VLS or media.

- Unload the magazine by pressing **ALT** and then **UNLOAD**. The magazine will move completely to the left.
- Open the VLS door and remove the magazine from the carriage.

Note

Some application packages may allow a magazine slot to be used for a cleaning cassette and automate its use. Refer to your application software manual.

- Check the usage record on the label of the cleaning cassette to make sure that there is at least one cleaning cycle remaining. If there are no cleaning cycles

remaining, discard the cleaning cassette and use a new one. Figure 15 shows a sample cleaning cassette with the label to write the date of each use.

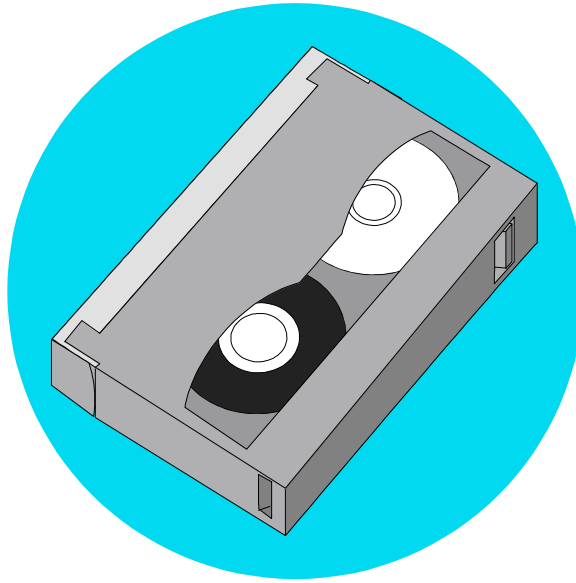

Figure 15. Representative Cleaning Cassette

- ❑ Insert cleaning cassette into the drive opening (see Figure 16). The drive will load the cassette and automatically begin the cleaning process. The cleaning cycle may take from 2 to 3 minutes.

Note

If there are no more cleaning cycles remaining for the cleaning cassette, the drive will eject it immediately after insertion

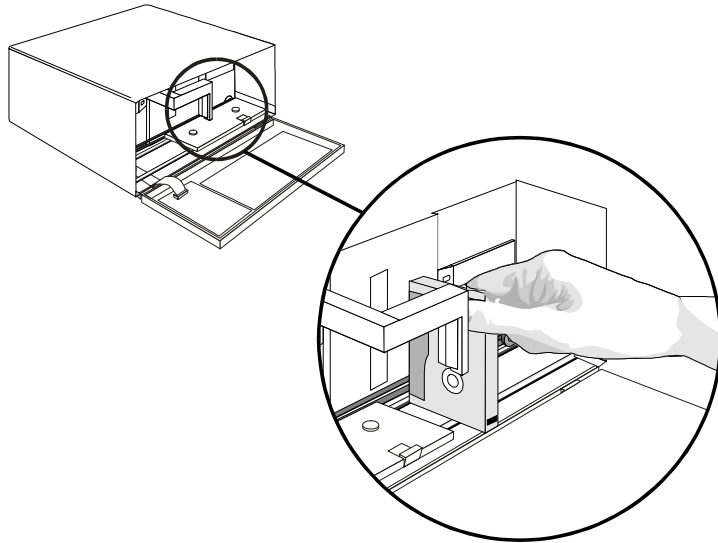

Figure 16. Inserting the Cleaning Cassette into the Drive.

- ❑ When the cleaning is finished the drive will automatically eject the cassette. Remove the cleaning cassette and write the date on the label so you have a record of how many times it has been used and when.
- ❑ To confirm that a cleaning was done, look at the LEDs on the front of the drive. If the cleaning cycle was successful, the left and right LEDs will be off. If the cleaning cycle was not performed, the LEDs will continue to flash.
- ❑ Place the magazine onto the carriage. Close the VLS door. Press **ALT** and then **LOAD** to initiate the load procedure.

Caution

Cleaning cassettes are considerably more abrasive to the drive's recording head than standard data cassettes. Usage should be kept within the recommended limits, or the warranty may not be applicable to the affected equipment

The VLS is once again ready for use.

Note

A hard error during normal operation can result in the Media Caution indication being displayed by the drive LEDs. If you encounter this situation, first try a new AIT data cassette. If this solves the problem, continue on with the new cassette.

If the symptom persists, try one cleaning cycle with the cleaning cassette. If this does not resolve the problem, we recommend that you do NOT use the cleaning cassette again – instead, call **adic's** Customer Assistance Center.

Cleaning the Enclosure

The outside of the enclosure can be cleaned with a damp towel. If you use a liquid all-purpose cleaner, apply it to the towel. Do not directly spray the enclosure.

Chapter 5

Troubleshooting and Diagnostics

This Chapter ...

- ❑ contains some general suggestions to aid you in solving problems – should you ever run into them.
- ❑ includes information on error codes and the built-in diagnostics.

VLS Error Messages

If any component of the VLS is not communicating correctly, a warning message will appear on the front display.

A list of error messages follows below. If the error you see is not on this list, please call **adic**'s Customer Assistance Center.

In all cases, after removing the cause of the problem (or if you can't find a cause) push **MENU** to return the VLS to the on-line condition.

If the error message is not listed, try to return to the on-line mode by pressing **ALT** and/or **ENTER**. If that does not work or if you get the error again, call **adic**'s Customer Assistance Center and be prepared to tell them what the error message is – and what the conditions are.

Error Messages

Note

Some, or all, of the error messages may result from one or more conditions. The definition given is for a single condition only. If you believe that the condition which caused your error message is other than the definition, please call **adic** Customer Assistance at: (206) 883-4357.

Error Name	Description
Source location empty	The source location was empty when the VLS attempted to pick a cartridge from it.
Destination location full	The destination location was full when the VLS attempted to place a cartridge in it.
Mag unload disabled by software	The application has issued the SCSI PREVENT/ALLOW MEDIA REMOVAL command, preventing the magazine from being unloaded.
Can't unload, media in drive	The VLS will unload the magazine only if all drives are empty.

Error Name	Description
Drive failed to eject media	The VLS attempted to return a cartridge to a magazine slot, but the drive had not previously ejected it.
Unexpected Gripper Arm Sensor break	The VLS sensed that the Gripper Arm Sensor was blocked when it should not have been.
Unexpected Magazine Sensor break	The VLS sensed that the Magazine Sensor was blocked when it should not have been.
No Gripper Arm Sensor break	The VLS sensed that the Gripper Arm Sensor was not blocked when it should have been.
No Magazine Sensor break	The VLS sensed that the Magazine Sensor was not blocked when it should have been.
Unexpected Medium Sensor break	The VLS sensed that the Medium Sensor was blocked when it should not have been.
Unable to return medium to slot	The VLS attempted to return a cartridge to a magazine slot but failed, possibly due to a magazine positioning error.
Unable to load medium in drive	The VLS attempted to load a cartridge into a drive but failed, possibly due to a drive positioning error.
Door has been opened	The front door of the VLS had been opened, but is now closed.
Door is open	The front door of the VLS is open. This error will appear whenever the front door is opened while power is on.
Operation disabled by keyboard lockout	
All configured drives are empty	The VLS received a command (through SCSI, or the front panel keypad) to unload medium from a drive, but, since the VLS had not previously loaded a cartridge, the drives are empty.
Slot not empty, can't unload drive	A cartridge is occupying the magazine slot currently aligned with the drive, and the VLS cannot place the cartridge ejected by the drive into this slot.
SCSI RESET OCCURRED	A SCSI RESET has occurred, coming from either the SCSI bus, or from the front panel keypad.
Drive positioning time-out	The drive shuttle failed to position correctly in the allowed time.
Flash RAM erase failure	The VLS could not successfully erase the Flash RAM during the firmware download process.

Error Name	Description
Flash RAM write failure	The VLS could not successfully write to the Flash RAM during the firmware download process.
NV-RAM selection failure	The VLS could not successfully select a particular area of the NV-RAM.
NV-RAM write failure	The VLS could not successfully write to the NV-RAM.
Boot ROM checksum failure	The checksum of the boot code in the Boot ROM is incorrect.
Unknown error code XXh	An unknown error has occurred.

Drive Warning Signals

The Sony SDX-300C drive uses its front panel LEDs that are set up to provide a pattern of warning signals. Figure 17 shows a close-up of the drive and the location of the front panel LEDs.

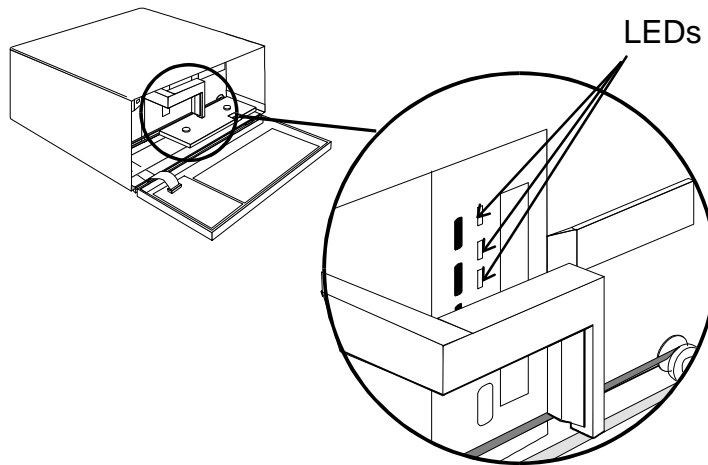

Figure 17. Position of Drive LEDs

LED Indicators

Figure 18 shows the drive's front panel, Table 1 shows the possible states of the 3 LEDs, Table 2 defines each of the drive's LED indications, and Figures 19 through 22 are timing diagrams of each of the flashing modes and codes.

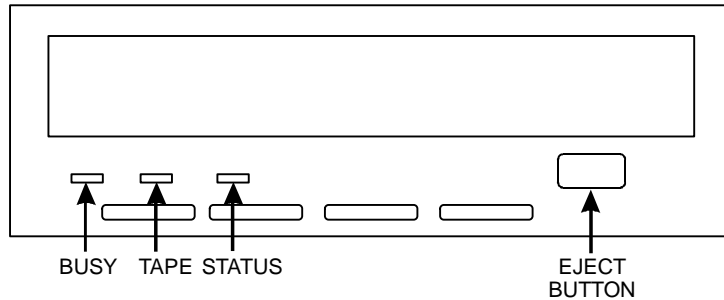

Figure 18 Drive Front Panel LEDs and Eject Button Location

LED State	Meaning
Off	Not active
On	Activity
Flashing - Mode 1	Drive Activity
Flashing - Mode 2	Warning
Flashing - Code 1 or 2	Failure

Table 1 Possible LED States

State	Busy LED	Tape LED	Status LED
Off	Not Busy	Unloaded	
On	SCSI Active	Loaded	Write Protected
Flashing - Mode 1	Drive Active	Loading/Unloading	Cleaning Tape at EOM
Flashing - Mode 2		Error Rate Warning	Cleaning Request
Flashing - Code 1	Waiting for Request	Waiting for Eject	
Flashing - Code 2			Self-Test Failure

Table 2 LED State Definitions

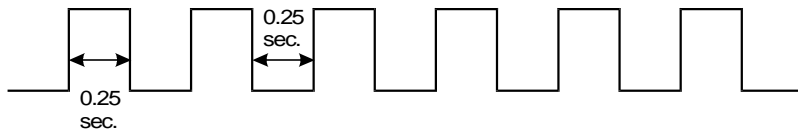

Flashing Mode 1: 0.25 sec ON/0.25 sec OFF

Figure 19 Flashing Mode 1 Timing Diagram

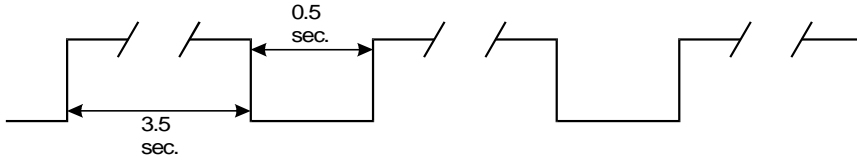

Flashing Mode 2: 3.5 sec ON/0.5 sec OFF

Figure 20 Flashing Mode 2 Timing Diagram

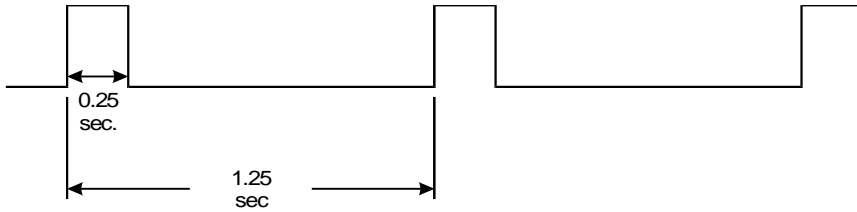

Flashing Code 1: **One Pulse**

Figure 21 Flashing Code 1 Timing Diagram

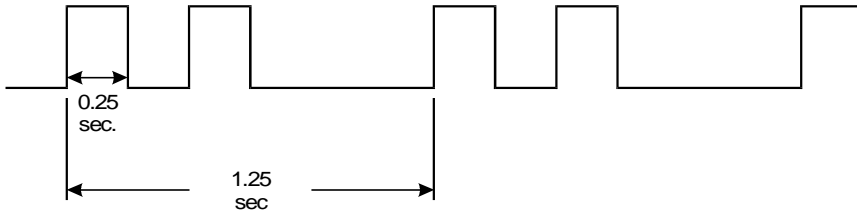

Flashing Code 2: **Two Pulses**

Figure 22 Flashing Code 2 Timing Diagram

Table 3 shows the possible LED indications for each drive state/condition:

State			LED		
Activity	Cartridge	Other	Busy	Tape	Status
None	None	None	OFF	OFF	OFF
SCSI	None	None	ON	OFF	OFF
Drive	Loading/ Unloading	None	Flashing - Mode 1	Flashing - Mode 1	OFF
Drive	Loading/ Unloading	Write Protected	Flashing - Mode 1	Flashing - Mode 1	ON
None	Loaded	Cleaning Tape at EOM	OFF	ON	Flashing - Mode 1
None	Loaded	None	OFF	ON	OFF
SCSI	Loaded	None	ON	ON	OFF
SCSI/Drive	Loaded	None	Flashing - Mode 1	ON	OFF
*	Loaded	Write Protected	*	ON	ON
*	*	Error Rate Warning	*	Flashing - Mode 2	*
*	*	Cleaning Request	*	*	Flashing - Mode 2
*	*	Self-test Failure	*	*	Flashing - Code 2
*	*	Waiting for Reset	Flashing - Code 1	*	*
*		Waiting for Eject	*	Flashing - Code 1	*
		Front Panel Test			

Table 3 Drive LED Indications

Environmental Considerations

For best performance of your VLS, please observe the following guidelines:

- If you expose cassettes to temperatures outside the operating limits – 40-113°F (5-40°C) – stabilize them by leaving the cassettes in the operating temperature for a minimum of two hours before you use them.
- Avoid temperature problems by ensuring that the rear and bottom of the VLS is not obstructed, so that the drive has adequate ventilation.
- Position the VLS where the temperature is relatively stable (i.e. away from open windows, fan heaters and doors).
- Avoid leaving cassettes in severe temperature conditions, for example, in a car standing in bright sunlight.
- Avoid transferring data (reading from and writing to cassettes) when the temperature is changing by more than 20°F (10°C) per hour.

When You Call **adic** Customer Assistance

Before calling **adic** Customer Assistance, follow these steps – which will help you take full advantage of your call:

- Review all documentation carefully. (Experience has demonstrated that most questions are answered in your documentation.)
- Be prepared to explain whether the software or hardware has worked properly at anytime in the past. Have you changed anything recently?
- Pinpoint the exact location of your problem, if possible. Note the steps that led to the problem. Are you able to duplicate the same problem or is it a one-time occurrence?
- Note any error messages displayed on your PC or file server screen. Write down the exact error message.
- If at all possible, call while at your computer, with **adic** 's system installed and turned on.
- If running on a network, have all relevant information available (i.e. type, version #, network hardware, etc.).

Be prepared to provide:

- Your name and your Company's name
- Model number
- Serial number of unit (located on the rear face by the power switch)
- Software version numbers
 - device driver
 - archive/restore
- Hardware configuration, including firmware version, date and number.
- Type of PC, DOS version, clock speed, RAM, network type, network version, and any special boards installed
- Type and brand of media
- A brief description of the problem
- Where you purchased the *adic* system

Note

Call *adic* Customer Assistance at (206) 883-4357.

- Having this information available when you call for customer assistance will enable *adic* to resolve your problem in the most efficient manner possible. Then call the Customer Assistance line.

Return for Repair RMA (Return Merchandise Authorization)

When you and *adic* Customer Assistance have determined that you need an RMA (see previous section *When You Call adic Customer Assistance*), be prepared with the following information:

Note

Be sure you have tried all trouble shooting techniques in the various manuals.

-
- Model number, serial number, and a brief, descriptive explanation of the problem.
 - Complete address information (be sure you give any mail stops or special codes at the time the RMA is issued).
 - If the item is NOT in warranty, you will be charged for the repairs. Therefore, the Customer Assistance personnel will need a P.O. number at the time the RMA number is issued. Until credit information can be obtained by your reseller's accounting department, the system may be shipped back COD to first-time customers.
 - It is also necessary to send the *complete* system, including the SCSI interface card/controller, interface cables, and the unit. Problems may have been caused by a defective external component and/or the drive itself.

Current labor rates will be quoted at the time the RMA is issued.

Loaner or replacement systems are generally NOT available. In extreme circumstances, they may be arranged for, depending on the nature of the problem and past history with the customer.

Keep the RMA number as a reference if you call to check on the status of an open RMA. It MUST also be written on the outside of the package for identification purposes.

Note

Following this RMA procedures will expedite handling, repairs and the return of equipment.

Appendix

A

Installing the Ferrite Bead

This Appendix ...

- ❑ describes how to install a ferrite bead (supplied) on the SCSI cable to assure compliance with EMI/RFI suppression specifications with dual VLS installations.

If you are using two or more VLS units on the same SCSI channel, you must install a ferrite bead on the interface cable between the units.

- ❑ Clip the clamp-on bead on the cable at any point between the two units. Refer to Figure **Error! Bookmark not defined.**

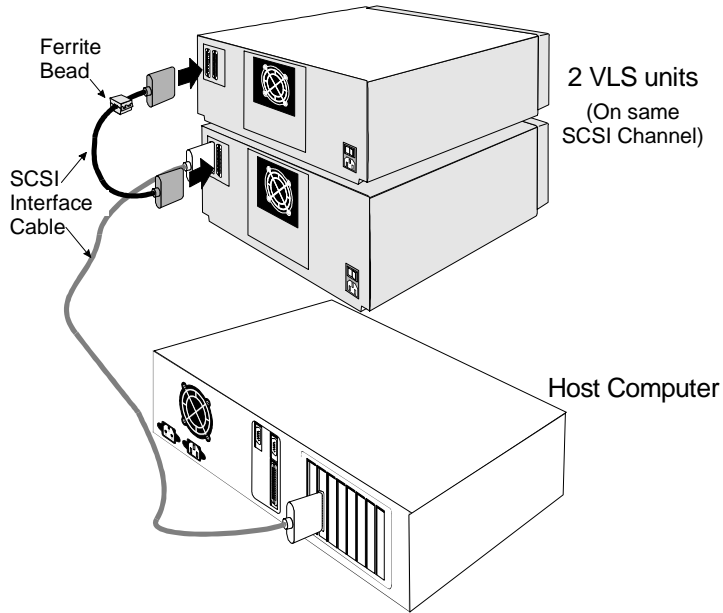

Figure 23 Installing the Ferrite Bead

The ferrite bead is required to satisfy the EMI/RFI suppression limits. The bead does not affect the functionality of your system in any way.

Appendix B

Diagnostics Menu

This Appendix ...

- ☐ describes the built-in diagnostic functions as available via the Diagnostics Menu.

One of the most valuable features of the VLS is the extensive built-in diagnostics. In this Appendix we discuss each of the Diagnostic functions available through the front panel keypad.

- ❑ To access the Diagnostics Menu, press the **MENU** button. The display will read as follows:



```
OFF-LINE MENU
Config Menu  ▾
```

- ❑ Press **DOWN** ▾ to access the Diagnostics Menu.
- ❑ Press **ENTER**; a display similar to the following will appear.



```
OFF-LINE MENU
Diag Menu   ▾
```

The following items are available under the Diagnostics Menu:

- Error Counters
- Operation Log
- Serial Number
- Position Magazine
- Unload Medium
- Event Counters
- F/W Revision
- Position Drive
- Load Medium
- Unload Drives

- ❑ Use **UP** ⬆ or **DOWN** ⬆ to scroll through the list.
- ❑ Press **ENTER** to choose a particular function.
- ❑ Use the **ESC** button to return to a previous menu (or to abandon current change).

Error Counters



```
ERROR COUNTERS
nnnnnnnnn#cccc
```

Provides a chronological listing (beginning with the last error issued) of the errors encountered by the VLS system. These are VLS internal hardware/firmware errors. This register records each error name and assigns it a sequential number.

nnnnnnnn = Counter name.
cccc = Counter value (0 - 65535)

Event Counters

```
EVENT COUNTERS  
nnnnnnnn#cccc
```

Provides a listing of the various VLS operations and how many times they have occurred.

nnnnnnnn = Counter name.
cccc = Counter value (0 - 65535)

Operation Log

```
OPERATION NNN →  
SCSI selection →
```

Provides a chronological logging (beginning with the latest) of up to 255 operations. These operations can be SCSI commands, operator requested operations, errors, and status operations. This information can be vital for trouble shooting problems. The following is a partial listing of some of the loggable operations. You may encounter other operations not included here.

NNN = Logged operation number (1-255).
When log is full, new operations are logged in as operation 255, scrolling the old operation 1 off the log.

Power on or user reset

Unit on-line due to user request

Unit off-line due to user request

Cmd: 03 00 00 00 20 00 (cmd from SCSI host adapter)
SCSI selection by SCSI ID N (N = SCSI ID of host adapter)
SCSI reselection of SCSI ID N
SCSI disconnect from SCSI ID N
SCSI status = 00h (status to SCSI host adapter)
Load magazine
Unload magazine
Door opened
Door closed
Position drive d (d = Drive A or B)
Position magazine to slot ss (ss = 01- 11)
Load from slot ss to drive d
Unload from d to slot ss
ERROR: Can't unload, media in drive(s)
ERROR: Source location empty
ERROR: Unexpected Gripper Arm Sensor brk
Retrying operation

Firmware Revision



```
F/W REVISION
Rev:VV.vv Date: *
```

Provides a record of the internal revision date and number. This information is vital for trouble shooting problems. Be prepared to provide this information to your reseller's Customer Assistance personnel if you ever need to talk with them. The following chart shows what each character in the sequence means.

VV	=	Major version number (00-99)
vv	=	Minor version number (00-99)
mm	=	Build-date month (01 - 12)

dd	=	Build-date day (01 - 31)
yy	=	Build-date year (00 - 99)
cccc	=	Internal checksum (0000 - FFFF)

Serial Number





Provides a record of the unit's unique hardware serial number. This information is vital for trouble shooting problems. Be prepared to provide this information to your reseller's Customer Assistance personnel if you ever need to talk with them. The following chart shows what each character in the sequence means.

cc	=	Model code
ss	=	Sequence number
y	=	Year code (one digit only)
m	=	Month code (one digit only)
dd	=	Day code
r	=	Revision level
l	=	Modification level



Position Drive



- Use the Position Drive function to line a drive up with the cassette window. Select drive A or B using **UP**  or **DOWN** .
- Press **ENTER** to activate.

Position Magazine

```
POSITION MAG
Slot number:05
```

- Use the Position Magazine function to line up the magazine with the on-line drive at a particular slot. Select the slot number using **UP**  or **DOWN** .
- Press **ENTER** to activate.





This option is usually used for diagnostics only by a trained technician.

ss = Slot number (01 - 15)

Load Medium

```
LOAD MEDIUM
Slot:ss Drive:d
```

The Load Medium function is used to line up the magazine with a particular drive at a particular magazine slot and load that cassette.

- Use **LEFT**  or **RIGHT**  to select the desired field. Select the slot and/or drive using **UP**  or **DOWN** . Press **ENTER** to activate.

This option is usually used for diagnostics only by a trained technician.





ss = Slot number (01 - 11)

d = Drive (A or B)

Unload Medium

```
UNLOAD MEDIUM
Slot:ss Drive:d
```

The Unload Medium function is used to line up the magazine with a particular drive at a particular slot so that the cassette will be placed in that slot when ejected.

☐ Use **LEFT**  or **RIGHT**  to select the desired field. Select the slot or drive using **UP**  or **DOWN** . Press **ENTER** to activate.

ss = Slot number (01 - 11)
d = Drive (A or B)

Note

If you have disabled a drive in the Drive Configuration Option (selected from the Configuration Menu) or there is no drive present, that drive field is not selectable.

This option is usually used for diagnostics only by a trained technician.

Unload Drives



```
UNLOAD DRIVES
All configured ▶
```

The Unload Drives function provides a message prompting the operator to manually eject media from the drive(s) and then returns the media to the magazine, or informs the operator that the drive(s) are empty.

If the VLS thinks that media is present in the drive(s) it will perform the following steps:

1. Aligns drive with cartridge window.
2. Verifies appropriate magazine slot is empty.
3. Aligns magazine slot with cartridge window.
4. Displays message: “Manually eject media
5. Waits until door is opened, then closed (because operator should have opened door, pressed eject button on drive, then closed door).
6. Checks that cartridge in transit sensor detects presence of media (because drive ejected cartridge).
7. Returns media to magazine.
8. Aligns second drive with cartridge window (if VLS thinks both drives contain media).

9. Repeats steps 2 through 7.

If the VLS thinks that the drive(s) are empty it will display: “All configured drives

This option is usually used for diagnostics only by a trained technician.

Appendix C

Downloading New Firmware

This Appendix ...

- ☐ explains the procedure for upgrading your VLS firmware.

Another of the special features built into the VLS series of adic products is the ability to upgrade firmware and built-in diagnostics at your installation site.

The process is simple. As upgrades become available upgrade diskettes will be provided along with all necessary instructions. Upgrading requires a PC and a SCSI interface with ASPI drivers. Current upgrade information and code will be available on adic 's BBS.

Appendix

D

Glossary

This Appendix ...

- contains terms and definitions of expressions commonly used with the VLS and the Sony SDX-300C.

AIT	Advanced Intelligence Tape is a new tape technology developed by Sony. It incorporates a new recording format, MIC (Memory In Cassette) capabilities, and uses AME (Advanced Metal Evaporated) media.
ALT	A front panel button used to activate the load/unload functions.
AME	AME (Advanced Metal Evaporated) is the tape formulation used by AIT. Key characteristics include 100% pure cobalt magnetic layer, dual magnetic layer design, the absence of binder material to prevent head contamination, and DLC (Diamond Like Carbon) protective coating for extreme durability.
byte	8 bits of digital data
C	Celsius (Centigrade)
cassette	A storage medium item. A cassette is sometimes called a tape or cartridge and is capable of storing vast amounts of magnetically-written data. Some cassettes can store more than 50 gigabytes of data.
cleaning cassette	Media used to clean the drive heads and tape path. Use only a Sony SDX-TCL cleaning cassette in the SDX-300C drive.
cm	centimeter (0.3937 inches)
FCC	Federal Communications Commission
ferrite bead	A device required to suppress radio noise in certain conditions to meet specifications.
GB	gigabyte (1 GB = 1,024 Megabytes)
HSM	Hierarchical Storage Management – a system where different types of storage media are used based on cost and time efficiency. For example, for fastest access, data is usually stored on a local hard drive. If you have a very large file that is needed occasionally, you may store it on a tape in a VLS magazine, or on an optical drive. In an HSM system, the data source should be transparent to the user.
Hz	Hertz (replacement for "cycles-per-second").
initiator	A host computer system that requests an operation to be performed by a target device.
KB	kilobyte (1 KB = 1,024 bytes)

keypad	Front panel on the VLS with 8 buttons used to activate the various functions of the VLS.
LCD	Liquid Crystal Display, a commonly used alphanumeric display that responds to specified input voltages and signals.
LED	Light Emitting Diode, a commonly used semiconductor device that glows when supplied with a specified voltage.
load	The process where the VLS checks each slot to see if a cassette is physically present, and if so, whether the orientation of the cassette in the magazine is correct. It also places the magazine in position for the first cassette to be inserted into the drive. In sequential mode, the first cassette is physically inserted into the drive.
magazine	The item that holds the tape cassettes for use by the VLS SDX. The SDX magazine holds 11 cassettes. The magazine also provides long-term covered storage of cassettes.
MB	megabyte (1 MB = 1,024 Kilobytes)
MIC	Memory In Cassette is a design innovation developed by Sony. Incorporating a Flash memory IC inside the AIT media cassette allows the architecture to capture various system and user-related statistics directly within the MIC structure to enhance data reliability, error prediction and success performance.
mm	millimeter (0.03937 inches)
POST	Power-On Self-Test is a built-in self-test for the 8mm drive. POST automatically occurs each time the VLS powers up.
random-access mode	Gives the software the ability to communicate with the robotics in such a way as to be able to access the cassettes in the magazine (and data on the cassettes) in any order. (Also see sequential-access mode.)
RMA	Return Merchandise Authorization.
RMA number	An identifying number given to a customer who needs to return equipment for repair, whether under warranty or not.

SCSI	Small Computer System Interface. An industry standard for connecting peripheral devices and their controllers to a microprocessor. The SCSI specification defines both hardware and software standards for communication between a host computer and a peripheral.
SCSI bus	Signal path or line shared by the devices on the same SCSI channel. Information is sent to all devices throughout the same bus; only the device to which it is addressed will accept or respond to it.
SCSI ID	The octal representation of the unique address (0 to 15 for SCSI-2 Fast/Wide buses) assigned to a SCSI device.
SDX	The series name of the media and hardware associated with the AIT format incorporated in a 3.5 inch form factor.
sequential-access mode	The cassettes in the magazine are inserted into the drive in a sequential manner, i.e. number 1 is first, number 2 is second, etc. When the last cassette is ejected from the drive, the sequence will either stop and the VLS will issue an error message, or loop back to the first cassette. (Also see random-access mode.)
Sony SDX-300C drive	Drive used in the VLS SDX. It is an enhanced SCSI-2 Fast/Wide, Single-Ended digital helical-scan cassette tape subsystem.
slot	The place within the magazine where the media is placed. Each slot has a reference position, i.e. position 1 through position 11.
terminator	A physical block that tells the SCSI bus that this is the end of the line. A terminator is required at both ends of a SCSI bus. A bus may be terminated internally (on a device inside the host system) or externally on a peripheral device.
unload	The process that returns the magazine to its resting position where it can be removed from the VLS unit.
VLS	Virtual Library System

Appendix

E

Specifications

This Appendix ...

- ❑ contains specification information on the VLS and the Sony SDX-300C drive.

Specifications

Drive:

Data Capacity:	Up to 50 GB per SDX cassette (compressed mode) Up to 550 GB per 11 cassette magazine (compressed mode)
Type:	Sony model SDX-300C (Optional dual drives available)
Data Transfer Rate:	Up to 180 MB/min. (single Sony drive, native mode) Up to 360 MB/min. (dual Sony drives, native mode)
Load Time:	20 seconds

Changer:

Magazine:	11 Cassettes
Media type:	Sony AIT data cassette
Cassette Change:	8 seconds, maximum
Indicators/Controls:	8 button keypad with LCD menu display, POWER LED and LOCKED LED to monitor and control system status, diagnostics and configuration
Interface:	SCSI-2 Fast/Wide, Single-Ended or Differential
Cassette Data Capacity:	25 GB per cassette, native mode (up to 50 GB compressed data, assuming an average compression ratio of 2:1)
Capacity:	550 GB for eleven cassettes (compressed mode)

Reliability

Maintenance:	Use cleaning cassette once a month, or when the drive displays the Cleaning Request message on the Status LED
MSBF:	Greater than 100,000 cassette changes (net, drive and media)
MTBF:	More than 80,000 power-on hours
MTTR:	Within 30 minutes

Physical

Dimensions: 17.4" (w) x 15.8" (d) x 8.0" (h)

Weight: 30 lb. (32 lb. with dual drives)

Power Consumption

Less than 65 Watts

Environment

Electrical: 100-240 VAC
Automatic AC line voltage selection

Temperature: 10° C to 40° C (Operating)
-40° C to 70° C (Storage/Shipping)

Humidity: 20% to 80% (Operating)
5% to 95% (Storage/Shipping)

Vibration: 0.25g (5-500 Hz) (Operating)
0.5g (5-500 Hz) (Storage/Shipping)

Shock: 2g Operating
30g Storage/Shipping

Blank Page



Index

—A—

alarm mode, 20
alarm sound, 20
archiving, 38

—B—

backup software, *xiv*, 2, 13, 16
Buzzer Configuration, 19, 20, 21

—C—

Cassette Change Time, 70
Cassette Data Capacity, 70
cassette labels, 29, 37
Changer Indicators/Controls, 70
Changer Interface, 70
Changer Maintenance, 70
Changer Mean Swaps Between Failures, 70
Changer Mean Time Between Failures, 70
Changer Mean Time To Repair, 70
Cleaning Cassette, 6, 36, 39, 40, 41, 42, 66, 70
cleaning frequency, 38
Cleaning the Drive Head, 6, 28, 38
Cleaning the Enclosure, 42
clearance, 2
Configuration Menu, 19, 20
confirmation of cleaning, 41
Connecting Multiple VLS Units, 11
Connecting the Interface Cables, 10
Copyright Notice, *iii*, *iii*
Customer Assistance, 6, 42, 44, 50, 51, 52

—D—

Data Transfer Rate, 70
Declaration of Conformity, *v*
Diagnostics Menu, 19, 25, 56
disabling drives, 23

display, 67
Drive Configuration, 19, 20, 23
drive eject button, 35, 36, 37, 61
drive head, 38, 39, 41
Drive Load Time, 70
drive status, 16
Drive Warning LEDs, 28, 37, 38, 46
Drive Warning Signals, 46
duplexing, 38
dust cover, 4, 29, 38

—E—

EMI/RFI Compliance, *iv*
EMI/RFI suppression limits, 54
environment, 38, 71
Environmental Considerations, 50
Equipment Description, 4
Error Counters, 19, 25, 56
error messages, 16, 44
Event Counters, 19, 25, 56, 57

—F—

ferrite bead, *iv*, 54, 66
Firmware Revision, 19, 25, 26, 58
firmware version, 51
front panel, 66
front panel display, 44
front panel keypad, 4, 16, 20, 56, 67
Front Panel LCD display, 16, 18, 67
Front Panel Lock, 16
Front Panel Locked LED, 17
Front Panel MENU button, 17, 20, 44, 56
Front Panel Power LED, 17
Front Panel Switches and Indicators, 16

—G—

Gripper Arm, 58

—H—

head, 4, 66
hierarchical storage management, 2, 66
host computer, *xii*, *xiv*, 2, 7, 10, 12, 13, 16, 18, 66, 67
host computer.power switch, 7
HSM, 2, 66
humidity, 71

—I—

I/O connector, 7
Inserting Data Cassettes into Magazine, 29
Inserting Magazine into VLS, 30
Installing Backup Software, 13
interface cable, *iv*, 10, 11, 52, 54

—K—

keypad, 70

—L—

LCD display, 70
Load Magazine, 32, 58
Load Medium, 19, 25, 56, 60
Loading Individual Cassette, 36
Loading Magazine with Cassette in Drive, 33
Locked LED, 70

—M—

magazine, *xiii*, 4, 5, 16, 17, 23, 28, 29, 30, 31, 32, 33, 34, 35, 36, 37, 38, 39, 41, 60, 61, 66, 67, 68
Magazine Data Capacity, 70
magazine position pin, *xiii*
magazine release, 34
Main Menu, 18

Manually Removing Cassette from Drive, 36
media, 4, 5, 25, 28, 39, 51, 58, 61, 66, 68, 70
Media Caution indication, 6, 38, 42
Media Picker, 13
Media Type, 70
mode of operation, 2

—N—

necessary tools, 3

—O—

off-line menu, 20
Off-line Mode, 17, 22
Off-line Time, 19, 20, 22
on-line, 22, 60
On-line Mode, 19, 20, 23
operating environment, 3
Operation Log, 19, 25, 56, 57

—P—

packing materials, 3
PC error messages, 50
Physical Attributes Dimensions, 71
pick arm, 30, 33
Position Drive, 19, 25, 56, 58, 59
Position Magazine, 19, 25, 56, 58, 60
Power Consumption, 71
Power LED, 70
power switch, 51
Powering on the System, 12
Precautions, *vii*
Preparing the Host Computer, 7

—Q—

Quickstart guide, *xi*

—R—

radio communication interference, *iv*
random-access mode, 2, 12, 23, 24, 33, 67
Rear Panel AC Power Connector, 18
Rear Panel Power Switch, 18
Rear Panel SCSI I/O Connectors, 18
Rear Panel Switches and Connectors, 18
Reliability, 70
Removing Cassette from Magazine, 37
Removing Magazine from VLS, 33
Removing Magazine with Cassette in Drive, 33, 35
Return Merchandise Authorization, 51, 67
RMA, 51, 52, 67
routine maintenance, 28

—S—

Safety Warnings, *vi*
SCSI address, 68
SCSI cable, 11
SCSI chain, *xii*, 7
SCSI channel, *iv*, 11, 12, 18, 54, 68
SCSI commands, 57
SCSI connector, *xii*, 10, 11
SCSI host adapter, 2, 3, 57, 58
SCSI ID, 12, 58
SCSI ID Configuration, 19, 20, 21
SCSI interface, *xii*, 7, 52, 64
SCSI interface cable, *xii*, 2, 10, 11
SCSI Parity, 19, 20, 22
sequential-access mode, *xiii*, 2, 12, 24, 33, 67, 68
Sequential-Access Mode Configuration, 19, 20, 24
Serial Number, 19, 25, 52, 56, 59
shielded cable, *iv*, 10
shock, 71
space requirements, 2
specifications, 66, 70

storage environment, 3
Storing the Magazine, 38
System Software, 6

—T—

tape head, 6
temperature problems, 50
terminator, *xii*, 11, 68

—U—

Unload Drives, 25, 56, 61
Unload Magazine, 58
Unload Medium, 19, 25, 56, 60
Unpacking and Inspecting, 3
upgrade firmware, 64

—V—

ventilation, 50
vibration, 71
VLS Error Messages, 44

—W—

warranty, *iii*, 4, 38, 41, 52
Write EEPROM Mode, 19, 26
write-protect switch., 5, 28